

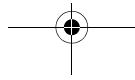

PHT-300X

Home Theater System

User's Manual

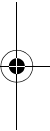
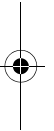

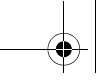

Spectroniq PHT-300X Home Theater System User's Manual.

© 2006 Protron Digital Corporation (DBA Spectroniq). All rights reserved.

Under copyright law, this manual may not be reproduced in any form, in whole or in part, without the prior written consent of Protron Digital Corporation (DBA Spectroniq).

Disclaimer

Protron Digital Corporation (DBA Spectroniq) has reviewed this manual and provides it only as a guide to operation. All statements, technical information, and recommendations in this manual and in any guides or related documents are believed reliable, but the accuracy and completeness thereof are not guaranteed or warranted, and they are not intended to be, nor should they be understood to be, representations or warranties concerning the products described.

Specifications are subject to change without notice.

Protron Digital Corporation (DBA Spectroniq)
P.O. Box 9148
Ontario, CA 91762

Printed in China

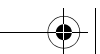
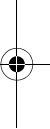

Important Safety Instructions

1. Read these instructions.
2. Keep these instructions.
3. Heed all warnings.
4. Follow all instructions.
5. Do not use this apparatus near water.
6. Clean only with a dry cloth.
7. Do not block any ventilation openings. Install in accordance with the manufacturer's instructions.
8. Do not install near any heat sources such as radiators, heat registers, stoves, or other apparatuses (including amplifiers) that produce heat.
9. Do not defeat the safety purpose of the polarized or grounding-type plug.
A polarized plug has two blades, one wider than the other.
A grounding-type plug has two blades and a third grounding prong.
The wide blade or the third prong are provided for your safety. If the provided plug does not fit into your outlet, consult an electrician for replacement of the obsolete outlet.
10. Protect the power cord from being walked on or pinched, particularly at plugs, convenience receptacles, and the point where they exit from the apparatus.
11. Only use attachments/accessories specified by the manufacturer.
12. Use only with the cart, stand, tripod, bracket, or table specified by the manufacturer or sold with the apparatus. When a cart is used, use caution when moving the cart/apparatus combination to avoid injury from tip-over.
13. Unplug this apparatus during lightning storms or when unused for long periods of time.
14. Refer all servicing to qualified service personnel. Servicing is required when the apparatus has been damaged in any way, such as when the power supply cord or plug is damaged, liquid has been spilled or objects have fallen into the apparatus, the apparatus has been exposed to rain or moisture, the apparatus does not operate normally, or the apparatus has been dropped.
15. To reduce the risk of fire or electric shock, do not expose this appliance to rain or moisture.
16. Do not expose apparatus to dripping or splashing and do not place objects filled with liquid on the apparatus.
17. Only use apparatus with battery specified by manufacturer.



Product Cautions



TO PREVENT POSSIBLE DANGER, ELECTRIC SHOCK, AND INJURY WHEN HANDLING YOUR HOME THEATER SYSTEM, PLEASE BE AWARE OF ALL WARNINGS AND SAFETY PRECAUTIONS LISTED BELOW.



Never spill any liquid of any kind on the system.

Never insert anything into any of the devices, where objects can come into contact with high voltage nodes or damage internal components.



Do not attempt to service the system yourself. Opening or removing covers exposes high voltage nodes and other hazards. Refer all servicing to qualified service personnel.



Do not touch any of the devices during thunderstorms. Unplug the system during thunderstorms or if it will not be used for extended periods. Failure to do so may result in electric shock or fire.

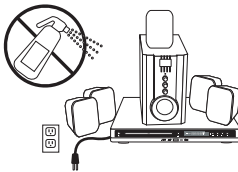

Before cleaning the system, turn it off and unplug it from the wall. Use a damp cloth for cleaning. Never use liquid or aerosol cleaners.

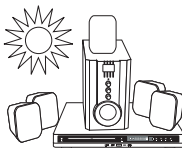

To prevent overheating and ensure reliable operation, place the system only in a well ventilated location. Avoid cramped or inadequately ventilated locations.

Note: Read all safety and operating instructions before operating your new home theater system.



CAUTION: Laser radiation when open. Do not stare into beam.

Explanation of Warning Symbols

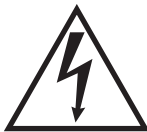

The lightning flash with arrowhead symbol, within an equilateral triangle, is intended to alert the user to the presence of uninsulated, dangerous voltage within the product's enclosure that may be of sufficient magnitude to constitute a risk of electrical shock to persons.



The exclamation point within an equilateral triangle is intended to alert the user to the presence of important operating and maintenance (servicing) instructions in the literature accompanying the appliance.

Conformity and Compliance

FCC Compliance Statement

This equipment has been tested and found to comply with the limits for a Class B digital device, pursuant to Part 15 of the FCC Rules. These limits are designed to provide reasonable protection against harmful interference when the equipment is operated in a residential installation. This equipment generates, uses, and can radiate radio frequency energy and, if not installed and used in accordance with the instructions, may cause harmful interference to radio communications. However, there is no guarantee that interference will not occur in a particular installation. If this equipment does cause harmful interference to radio or television reception (this can be determined by turning the device off and on), the user is encouraged to try to correct the interference by one or more of the following measures:



- Reorient or relocate the receiving antenna.
- Increase the separation between the equipment and the receiver.
- Connect the equipment to an outlet on a circuit different from that to which the receiver is connected.
- Consult the dealer or an experienced radio/TV technician for help.

Caution:

To comply with the limits for an FCC Class B computing device, the user should use the shielded signal cable and power cord supplied with the unit. The FCC warns that changes or modifications of the unit not expressly approved by the party responsible for compliance could void the user's authority to operate the equipment.

Radio Frequency Interference Statement

Warning:

This is a Class B product. In a domestic environment this product may cause radio interference, in which case the user may be required to take adequate measures.

UL Mark and Statement

This device is a UL Listed product. UL has found that representative samples of this product met UL's safety requirements.



Canadian DOC Notice for Class B Computing Devices

This digital apparatus does not exceed the Class B limits for radio noise emissions from a digital apparatus as set out in the Radio Interference Regulations of the Canadian Department of Communications.

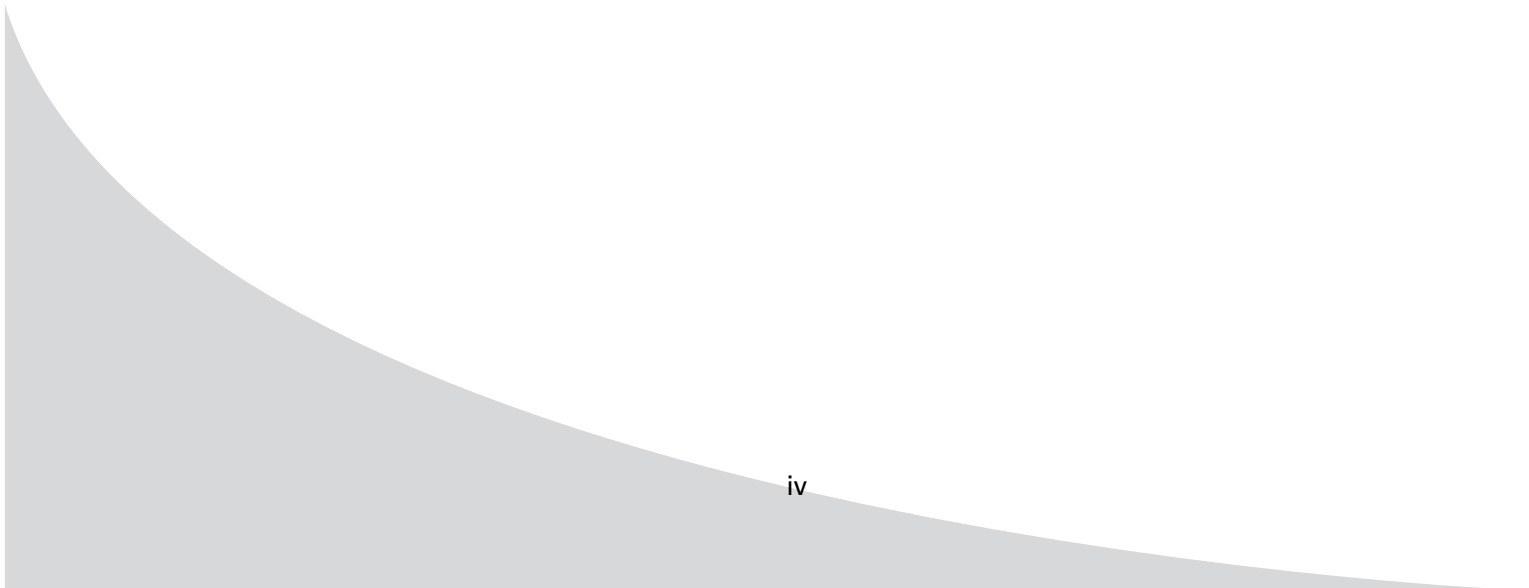
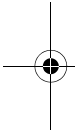



Table of Contents

Introduction	1
Features	1
Unpacking Your New Home Theater System	2
Setting Up the System	3
Connecting to Other Devices	6
Connecting to a Display Using Composite Video	6
Connecting to a Display Using S-Video	7
Connecting to a Display Using Component Video	7
Connecting to an Audio System	8
Operating the System	9
Turning the System On and Off	9
Inserting a Disc	9
Adjusting the Volume	9
Understanding the Readout	9
Bringing Up the On-Screen Display	10
Accessing the Setup Menu	10
Using the Remote Control	11
Replacing the Remote Batteries	14
Playing DVDs	15
The On-Screen Display	15
Navigating Menus	15
Controlling Playback	15
Selecting the Audio Channel	15
Selecting the Subtitle Channel	15
Repeating Chapters	15
Repeating an Arbitrary Section	16
Searching to a Specified Location	16
Bookmarking Locations	16
Playing Video CDs	17
The On-Screen Display	17
Using Playback Control	17
Navigating Menus	17
Controlling Playback	17
Repeating Tracks	17
Repeating an Arbitrary Section	18
Playing Audio CDs	19
The On-Screen Display	19
Controlling Playback	19
Repeating Tracks	19
Repeating an Arbitrary Section	19
Searching to a Specified Location	19
Bookmarking Locations	20
Playing Media on Data CDs	21
Controlling Playback	21
The On-Screen Display	21
Navigating the Directory Structure	21
Repeating Tracks	21
Manipulating Images	21
Using Slideshow Transition Effects	22

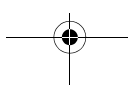
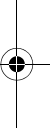
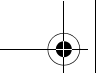



Table of Contents

Kodak Picture CDs	22
Configuring the Player	23
Language	23
Video	24
Audio	25
Rating	26
Misc.	26
Troubleshooting	27
Support Information	28
Specifications	29
General	29
Speaker System	29
Video	29
Audio	29
Limited Warranty	30





Introduction

Congratulations on purchasing your new Spectroniq Home Theater System!

Your new home theater system offers a wide range of features. In addition to playing video, it can play music and photo CDs so you can listen to music or browse photo albums using your television set.

With composite, S-Video, and component video outputs, you can connect the player to any display. And progressive scan video output capability provides the highest video quality available.

The included 300 watt, 5.1 channel surround sound speaker system gives you realistic 3D audio for the most immersive movie experience.

Features

- 300 watt, 5.1 channel surround sound speaker system
- Fully compatible with DVD, DVD+R/RW, Audio CD, Video CD, Super Video CD, Kodak Picture CD, CD-ROM, and CD-R/RW media
- Displays JPEG images stored on data CDs
- Plays MP3 files stored on data CDs
- 24-bit, 96kHz digital audio converters for high fidelity sound
- Dolby Digital surround sound
- Composite video output
- S-Video output
- Progressive scan component video output
- 5.1 channel audio output
- Digital coaxial and optical audio outputs

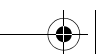
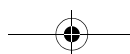

Unpacking Your New Home Theater System

Before setting up your new home theater system, you should unpack the contents of the box and check to make sure everything is present and undamaged.

To unpack the system:

1. Open the box. Remove the player and styrofoam pads.
2. Remove the styrofoam pads from the player. Remove the remote from inside the right pad.
3. Remove the speakers from the box. There should be five speakers and a subwoofer.
4. In addition to the player and speakers, the box should contain the items indicated below. If anything is missing or damaged, contact the seller immediately.

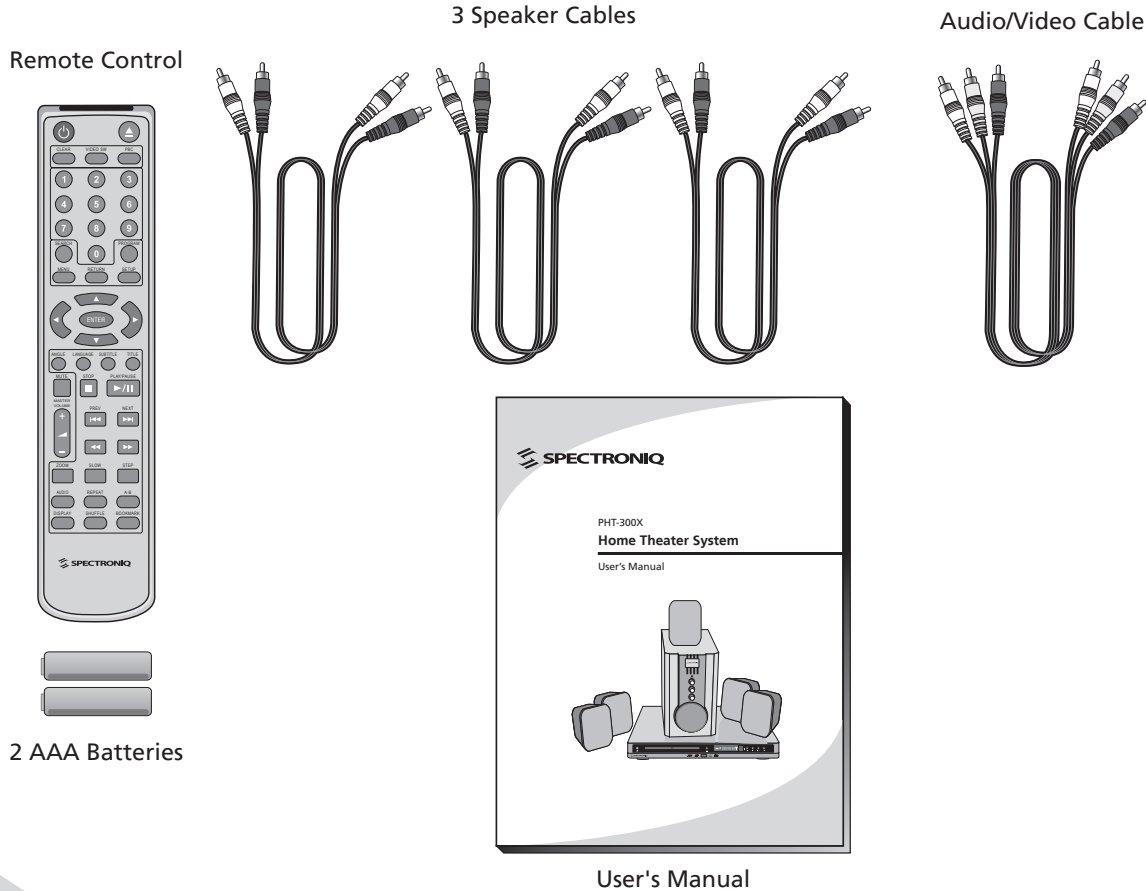
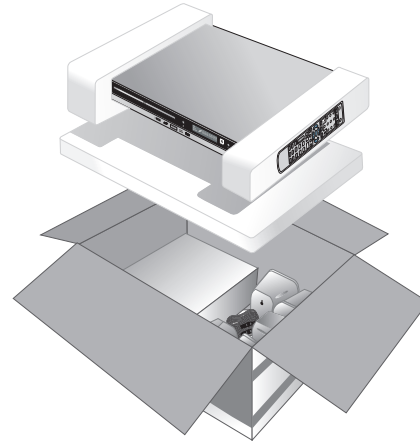

Setting Up the System

The following is the procedure for setting up your home theater system, complete with 5.1 channel surround sound system.

To set up the system:

1. Set the player in its intended location.
2. Connect the five speakers to the five AUDIO OUTPUT terminals on the back of the subwoofer. For each speaker, connect the wire with the white stripe on it to the – terminal, and connect the other wire to the + terminal. For example, for the center speaker, connect the white-striped wire to CEN– and the other to CEN+.

To connect a wire, press down the tab, insert the wire, then release the tab to capture the exposed end of the wire.

3. Using the speaker cables, connect the the 5.1 channel audio outputs on the back of the player to the associated AUDIO INPUT connectors on the back of the subwoofer. The outputs on the player have the same layout as the inputs on the subwoofer, but rotated.

You can also use the auxiliary input above the 5.1 channel terminals (labeled L and R) to connect a separate audio source to the speaker system.

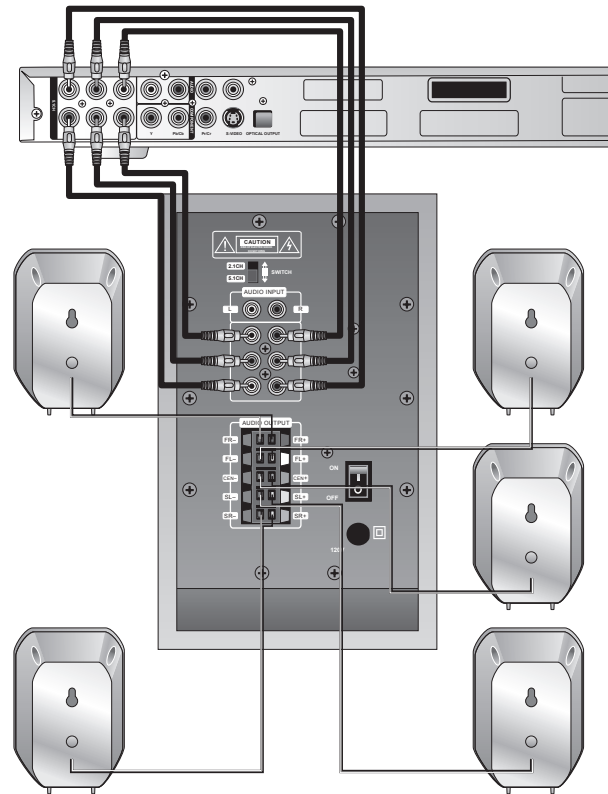

Setting Up the System

4. Place the speakers as indicated below. For the best possible listening experience, all speakers (except the subwoofer) should be placed at the same distance from the listening position.
- Subwoofer (SUB)—Place on the floor near the display
 - Center speaker (CEN)—Place above or below the display, centered
 - Front speakers (FL, FR)—Place on each side of and at an equal distance from the display, at approximately 45 degrees from the listening position
 - Side speakers (SL, SR)—Place on each side of and at an equal distance from the listening position, facing the listening position at ear level

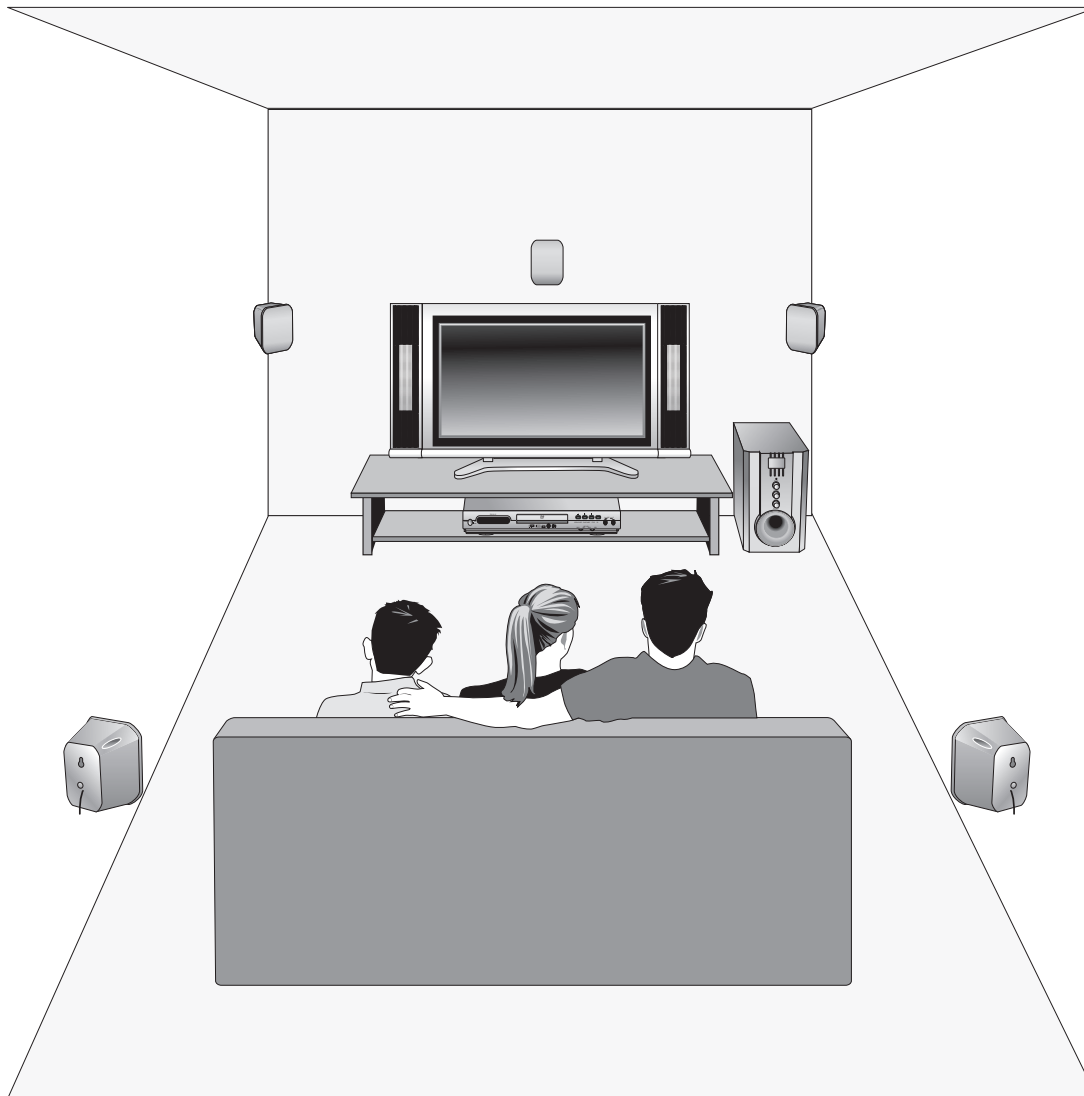

Setting Up the System

5. Set the 2.1CH/5.1CH switch on the back of the subwoofer to 5.1CH.
6. Plug the subwoofer into a wall socket.

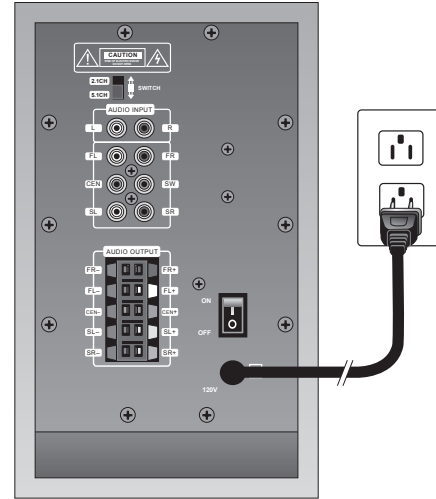

7. Plug the player into a wall socket.

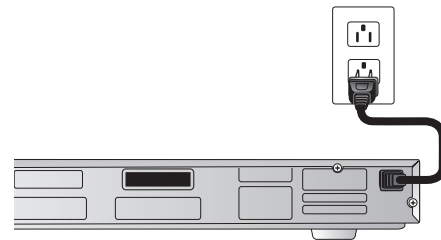

8. Install two AAA batteries (included) in the remote. Ensure they are oriented as indicated in the battery compartment.

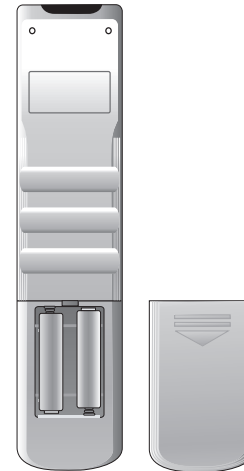

Connecting to Other Devices

Before using your home theater system for the first time, you will need to connect it to a display. In addition, you may want to connect the player to a separate audio system.

Connecting to a Display Using Composite Video

Composite video, though the lowest quality of the three video outputs on the player, is the most common format and so can be found on just about any display.

To connect to a display using composite video:

1. Using the included audio/video cable (see the accessories on page 2), connect one yellow RCA connector to the composite video input on the display, and attach the other yellow RCA connector to the yellow video jack on the rear of the player.
2. (OPTIONAL) To connect the audio output to the display as well, use the red (right) and white (left) RCA connectors on the included audio/video cable to connect the AUDIO jacks on the rear of the player to the display's audio input.
3. Select **YUV** as the Video Output setting under the Video setup menu on the player (see "Configuring the Player" on page 23).
4. Select the appropriate TV Shape and TV System settings under the Video setup menu.

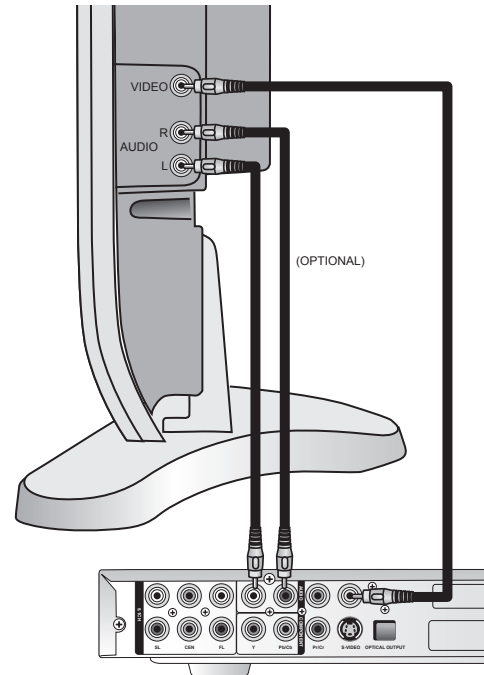

Connecting to a Display Using S-Video

S-Video provides better image quality than composite video, but lower image quality than component video. It is available on most displays.

Note: The pins used in S-Video connectors are fragile. Use care when handling S-Video cables to avoid bending or breaking pins.

To connect to a display using S-Video:

1. Using an S-Video cable, connect the S-VIDEO output on the player to the S-Video input on the display.
2. (OPTIONAL) To connect the audio output to the display as well, use the red (right) and white (left) connectors on the included audio/video cable to connect the AUDIO jacks on the rear of the player to the display's audio input.
3. Select **S-Video** as the Video Output setting under the Video setup menu on the player (see "Configuring the Player" on page 23).
4. Select the appropriate TV Shape and TV System settings under the Video setup menu.

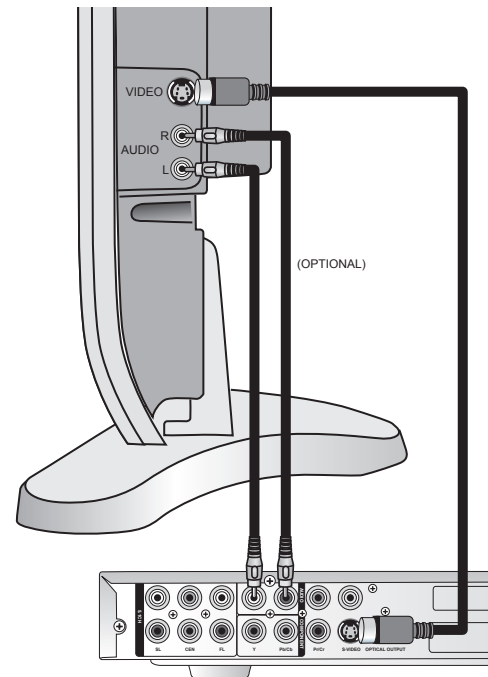

Connecting to a Display Using Component Video

The progressive scan component video output on your DVD player provides the highest quality video available.

Note: To be able to use a component video connection, your display must also support progressive scan video.

To connect to a display using component video:

1. Use three RCA cables to connect the Y, Pb/Cb, and Pr/Cr jacks on the rear of the player to the corresponding component video inputs on the display.
2. (OPTIONAL) To connect the audio output to the display as well, use the red (right) and white (left) connectors on the included audio/video cable to connect the AUDIO jacks on the rear of the player to the display's audio input.
3. Select **YPbPr** as the Video Output setting under the Video setup menu on the player (see "Configuring the Player" on page 23).
4. Select the appropriate TV Shape and TV System settings under the Video setup menu.

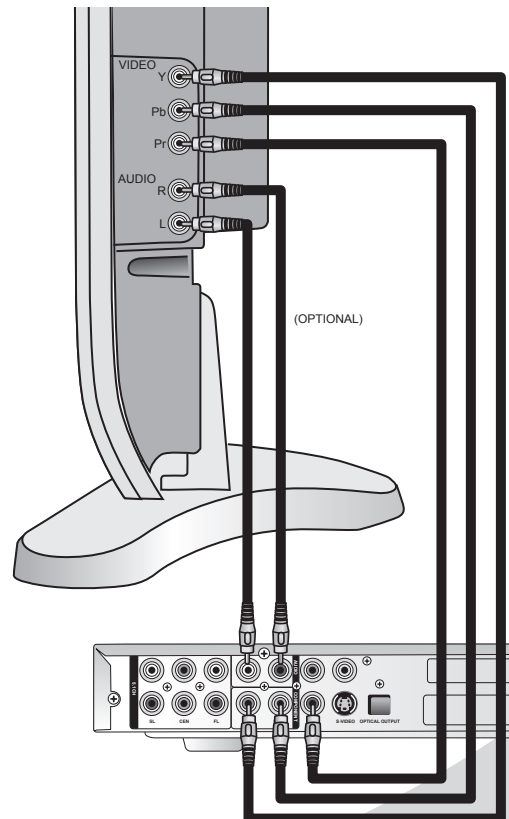

Connecting to Other Devices

Connecting to an Audio System

There are several different outputs that can be used to connect to an external audio system: 5.1 channel analog, stereo analog, and digital.

To connect to an audio system using 5.1 channel analog audio:

1. Use the three included speaker cables (see the accessories on page 2) to connect the 5.1 channel audio jacks on the rear of the player (from top left to bottom right: SR—side right, SUB—subwoofer, FR—front right, SL—side left, CEN—center, and FL—front left) to the corresponding inputs on the audio system.

Note: If you are using the 5.1 channel audio outputs to connect to a separate audio system, you cannot use the included speaker system.

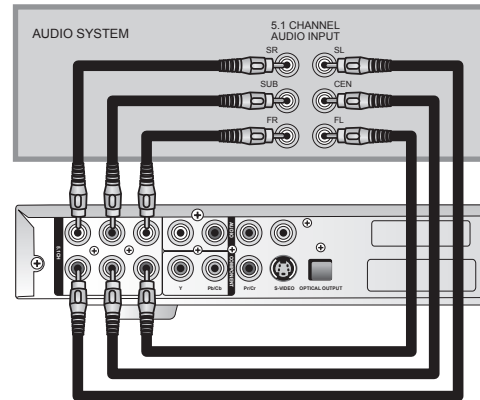

To connect to an audio system using stereo analog audio:

Use two RCA cables to connect the AUDIO jacks on the rear of the player to a stereo input on the audio system.

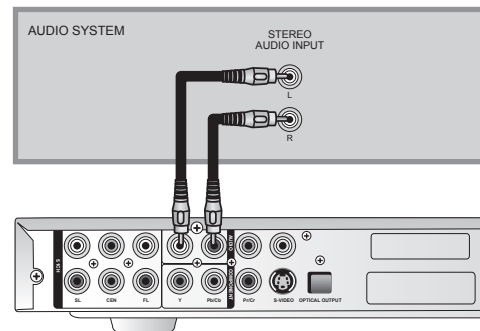

To connect to an audio system using coaxial digital audio:

1. Use a digital coaxial cable to connect the orange coaxial output (to the right of the AUDIO jacks) on the player to a coaxial S/PDIF audio input on the audio system.
2. Select the appropriate Digital Output setting under the More Aud setup menu on the player (see "Configuring the Player" on page 23).

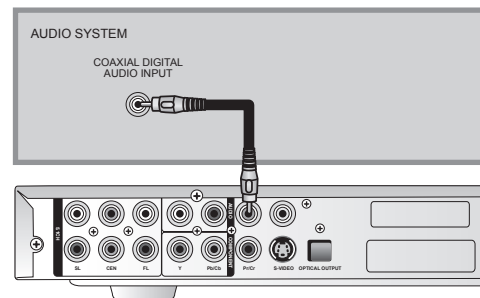

To connect to an audio system using optical digital audio:

1. Use a TOSLINK™ cable to connect the OPTICAL output on the player to an optical S/PDIF audio input on the audio system.
2. Select the appropriate Digital Output setting under the More Aud setup menu on the player (see "Configuring the Player" on page 23).

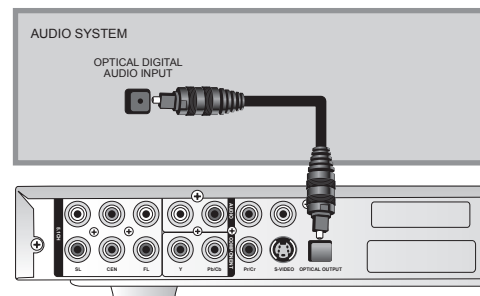

Operating the System

Turning the System On and Off

Once the player is connected to a power outlet, turn the player on and off by pressing the power button on the player.

When the power button on the player is on, you can also press the power button on the remote to turn the player on and off.

To turn the speaker system on and off, use the ON/OFF switch on the back of the subwoofer.

Inserting a Disc

The receptacle for DVDs and CDs is located on the front of the player.

To insert a disc:

1. Press the eject button to open the receptacle.
2. Insert the disc, blank side down.
3. Press the eject button to close the receptacle. The player will begin to play the disc.

Adjusting the Volume

Use the **MASTER VOLUME** buttons on the remote to adjust the player's output volume.

Use the **VOLUME** knob on the subwoofer to adjust the speakers' output volume.

Use the **BASS** knob on the subwoofer to adjust the bass volume.

Use the **BALANCE** knob on the subwoofer to adjust the front/rear audio balance.



Understanding the Readout

The readout on the front of the player displays information about the current disc and playback. The following is a description of each of the indicators on the readout.



Indicator	Indication
Number Display	DVDs, Audio CDs, Video CDs, MP3 CDs: The current playback time Picture CDs: The current image number
MP3/VCD/DVD	The current disc type: <ul style="list-style-type: none"> • DVD—DVD or DVD±R/RW • VCD—Video CD • MP3—MP3 CD
▶	The player is playing the current disc.
	The current disc is paused.

Operating the System

Indicator	Indication
PBC	Playback control is on (Video CDs). When playback control is on, the Video CD's menu will be available.
	The player is in a repeat mode.
	DTS multi-channel sound is enabled.
	Dolby Digital multi-channel sound is enabled.

Bringing Up the On-Screen Display

The On-Screen Display (OSD) gives information about the current disc and playback. To bring up the OSD, press the **DISPLAY** button on the remote.

Accessing the Setup Menu





The Setup menu allows you to configure the operation of the player. You can change video, audio, and language settings, control access to mature programming, and configure other general behavior. See "Configuring the Player" on page 23 for more information. To access the Setup menu, press the **SETUP** button on the remote.

Using the Remote Control











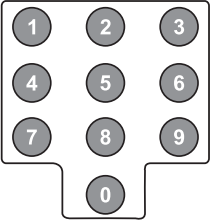





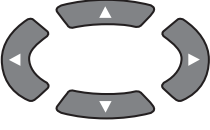













The remote control can be used to control every aspect of the player's operation and includes more functionality than the controls on the player itself.

The following is a list of all buttons on the remote and their functions.

Button	Function
	Turns the player on and off
	Opens and closes the disc receptacle
	Erases an entry
	Selects the video output used by the player: Component (YPbPr), S-Video, or Composite (YUV)

Using the Remote Control

Button	Function
	When playing DVDs or Video CDs, turns off playback control to enable playback sequence programming using the PROGRAM button. In addition, when playback control is off, the player will skip the root menu on a Video CD when the disc is inserted and begin playback with the first track.
	Used to enter numbers and navigate directly to a specified track (audio CDs and Video CDs), chapter (DVDs), or photo (photo CDs)
	Brings up the search display, which you can use to skip to a specified location
	Brings up the program display, which allows you to program playback sequence
	When playing a DVD, this button returns to the previous menu. When playing a Video CD, turns playback control (menu play) on and off. When playback control is on, any menu on the disc will display when the player begins playing the disc, and the menu will be accessible by pressing RETURN . When off, playback will begin with the first track, and the menu will not be available.
	When playing a DVD, this button returns to the menu. When viewing a DVD menu, this button resumes DVD playback.
	Brings up the Setup menu and pauses playback
	Used to navigate menus and displays
	Confirms the current selection or entry
	Changes the filming angle when playing back a multi-angle DVD
	Cycles through the available audio languages on a DVD
	Cycles through the available subtitle channels on a DVD
	Displays the title menu on a DVD
	Mutes the audio

Button	Function
	Adjusts the audio volume
	Stops playback. Press twice to completely stop a disc.
	When in normal play mode, this button pauses and resumes playback.
	Returns to the previous chapter, track, or photo
	Skips to the next chapter, track, or photo
	Reverses DVD or CD playback. Pressing this button repeatedly cycles through the reverse speeds.
	Fast forwards the DVD or CD. Pressing this button repeatedly cycles through the fast forward speeds.
	Zooms in on the picture. Pressing this button repeatedly cycles through the zoom levels.
	Slows down the playback speed of a DVD. Pressing this button repeatedly cycles through the available speeds.
	Steps forward one frame at a time
	Cycles through the available audio channels on a DVD. When playing back an audio CD, this button cycles through stereo, mono (left channel), and mono (right channel) playback.
	Cycles through the available repeat modes
	Marks an arbitrary section to be repeated
	Brings up the On-Screen Display (OSD), which shows current playback information
	Plays the chapters (DVDs) or tracks (audio CDs and Video CDs) on a disc in random order
	Brings up the bookmark display, which allows you to save locations on the current disc so you can return to them later

Note: If a circle with a slash through it appears upon pressing a button on the remote, it means that the button you have pressed does not function in the current mode or for the disc in the player.

Using the Remote Control

Replacing the Remote Batteries

The remote requires two AAA batteries, which are held in a small enclosure on the rear of the remote.

To replace the batteries:

1. Slide the cover off the bottom of the remote.
2. Remove the old batteries and replace them with the new batteries. Ensure the batteries are oriented as indicated in the enclosure.
3. Slide the cover back onto the remote.

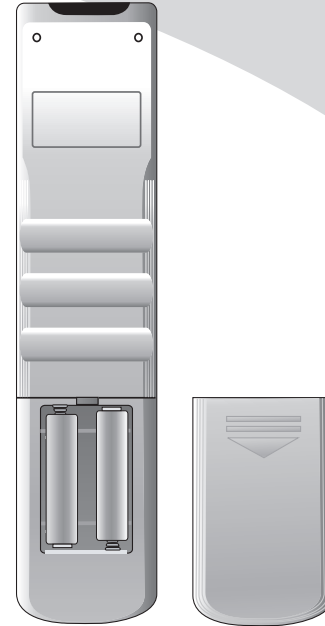

Playing DVDs

DVDs will play upon insertion. The player can perform all standard DVD playback and search functions.

The On-Screen Display

The DVD OSD has five modes:

- Press **DISPLAY** once to show the current playback time.
- Press **DISPLAY** a second time to show the current title and chapter.
- Press **DISPLAY** a third time to show the current audio channel.
- Press **DISPLAY** a fourth time to show the current subtitle channel.
- Press **DISPLAY** a fifth time to show the current shot angle.

Navigating Menus

When in a DVD menu, use the arrow controls to navigate, and press **ENTER** to select an item.

Press **MENU** to return to the previous menu.

Controlling Playback

When playing a DVD, use the following keys to navigate:

Press **■** to stop the DVD at the current location. Press **■** a second time to stop the DVD completely.

When the DVD is playing, press **▶||** to pause it.

Press **◀◀** to return to the previous chapter.

Press **▶▶** to skip to the next chapter.

Press **◀◀** to fast reverse the DVD. Press **▶▶** to fast forward the DVD. Repeated presses cycle through the speed options: 2x, 4x, 8x, or 16x.

Press **SLOW** to play the video at a slower speed. Repeated presses cycle through the speed options: $\times 1/2$ and $\times 1/4$.

Press **▶||** to return to normal play mode or to start playing the DVD again when it is stopped or paused.

Press **MENU** to return to the DVD menu.

Selecting the Audio Channel

Press **AUDIO** to cycle through the available audio channels.

Selecting the Subtitle Channel

Press **SUBTITLE** to cycle through the available subtitle languages.

Repeating Chapters

Press **REPEAT** to cycle through the repeat options: the current chapter, the current title, and off.

Playing DVDs

Repeating an Arbitrary Section

You can repeat an arbitrary section of video using the **A-B** button.

To repeat an arbitrary selection:

1. Press **A-B** to mark the beginning of the section to be repeated.
2. Press **A-B** again to mark the end of the section.

The section will begin repeating and will continue until you press **A-B** again.

Searching to a Specified Location

You can skip to a specified title and chapter or time using the **SEARCH** button.

To search to a chapter, title, or time:

1. Press **SEARCH** once to bring up the Search display.
2. Press **▲** and **▼** to select **Chapter, Title, or Time**.
3. Enter the desired location using the keypad on the remote.
4. Press **ENTER** to search to the specified location.

To exit the Search display without going to a location, press **SEARCH** once more.

Bookmarking Locations

You can save up to three locations on the CD and then jump to them later using the **BOOKMARK** button.

To bookmark a location:

1. Press **BOOKMARK** to bring up the Bookmark display.
2. Select an empty bookmark by pressing **▲** and **▼**.
3. Press **ENTER**.

To jump to a saved bookmark:

1. Press **BOOKMARK** to bring up the Bookmark display.
2. Select the desired bookmark by pressing **▲** and **▼**.
3. Press **ENTER**.

To erase a bookmark:

1. Press **BOOKMARK** to bring up the Bookmark display.
2. Select the bookmark to be cleared by pressing **▲** and **▼**.
3. Press **CLEAR**.

Playing Video CDs

Video CDs can contain video or still images, such as photos. Your portable DVD player will play all standard Video CD formats.

Upon insertion, the player will read and begin to play the CD.

If there is a menu on the CD, it will appear, allowing you to navigate through the tracks stored on the CD. Otherwise, the player will begin playing the video back beginning with the first track.

If the CD contains still pictures, the player will display them as a slideshow.

The On-Screen Display

The Video CD OSD (press **DISPLAY**) shows the Video CD type, current track, current playback time, and current time remaining.

Using Playback Control

Pressing **MENU** turns playback control (menu play) on and off.

When playback control is on, any menu on the disc will display when the player begins playing the disc, and the menu will be accessible by pressing **RETURN**.

When playback control is off, playback will begin with the first track, and the menu will not be available.

Navigating Menus

Press **◀** and **▶** to scroll through menu pages.

To view an item, enter its number on the keypad and then press **ENTER**.

Note: To view an item, the menu page containing the item must be visible before you enter the item's number.

Controlling Playback

Press **▶** to move to the next track or image.

Press **◀** to return to the previous track or image.

Press **◀◀** to fast reverse the video. Press **▶▶** to fast forward the video. Repeated presses cycle through the speed options: 2x, 4x, 8x, or 16x.

Press **SLOW** to play the video at a slower speed. Repeated presses cycle through the speed options: $\times 1/2$ and $\times 1/4$.

Press **▶||** to pause the video or slideshow.

Press **■** once to stop playback. Press **■** a second time to completely stop the disc.

Press **▶||** to return to normal play mode or to start playing the disc again when it is stopped.

Press **RETURN** to return to the menu.

Repeating Tracks

Press **REPEAT** to cycle through the repeat options: the current track, all tracks on the disc, and off.

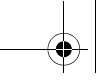

Playing Video CDs

Repeating an Arbitrary Section

You can repeat an arbitrary section of video using the **A-B** button.

To repeat an arbitrary selection:

1. Press **A-B** to mark the beginning of the section to be repeated.
2. Press **A-B** again to mark the end of the section.

The section will begin repeating and will continue until you press **A-B** again.

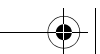
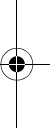

Playing Audio CDs

Audio CDs will play upon insertion. All standard Audio CD navigation features are available.

The On-Screen Display

The Audio CD OSD displays a list of tracks on the disc. Select a track and press **ENTER** to play it back.

Press **▶** to access the options on the right of the screen. Use **▲** and **▼** to highlight an option, then press **ENTER** to select or change it.

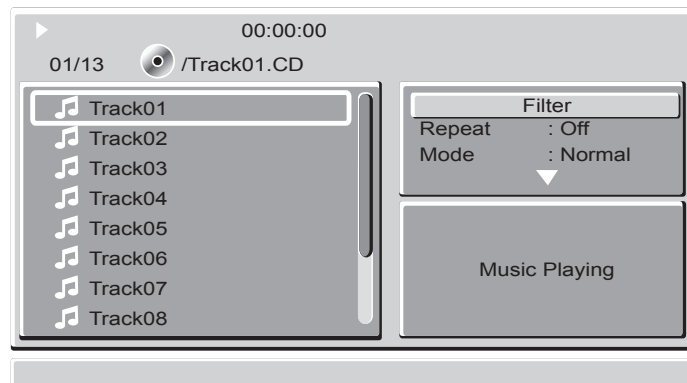

Controlling Playback

Press **▶||** to pause playback.

Press **■** once to stop CD playback at the current location. Press **■** a second time to stop CD playback completely.

Press **◀◀** to return to the previous track.

Press **▶▶** to skip to the next track.

Press **◀◀** to fast reverse the audio. Press **▶▶** to fast forward the audio. Repeated presses cycle through the speed options: 2x, 4x, 8x, or 16x.

Press **▶||** to return to normal play mode or to start playing the disc again when it is stopped.

To skip directly to a track, enter the track number on the keypad and then press **ENTER**.

Repeating Tracks

Press **REPEAT** to cycle through the repeat options: the current track, all tracks on the disc, and off.

Repeating an Arbitrary Section

You can repeat an arbitrary section of audio using the **A-B** button.

To repeat an arbitrary selection:

1. Press **A-B** to mark the beginning of the section to be repeated.
2. Press **A-B** again to mark the end of the section.

The section will begin repeating and will continue until you press **A-B** again.

Searching to a Specified Location

You can skip to a specified time or track using the **SEARCH** button.

To search to a track or time:

1. Press **SEARCH** once to bring up the Search display.
2. Press **▲** and **▼** to select **Track**, **Time** (time in current track), or **Disc Time** (absolute time on disc).

Playing Audio CDs

3. Enter the desired location using the keypad on the remote.
4. Press **ENTER** to search to the specified location.

To exit the Search display without going to a location, press **SEARCH** once more.

Bookmarking Locations

You can save up to three locations on the CD and then jump to them later using the **BOOKMARK** button.

To bookmark a location:

1. Press **BOOKMARK** to bring up the Bookmark display.
2. Select an empty bookmark by pressing ▲ and ▼.
3. Press **ENTER**.

To jump to a saved bookmark:

1. Press **BOOKMARK** to bring up the Bookmark display.
2. Select the desired bookmark by pressing ▲ and ▼.
3. Press **ENTER**.

To erase a bookmark:

1. Press **BOOKMARK** to bring up the Bookmark display.
2. Select the bookmark to be cleared by pressing ▲ and ▼.
3. Press **CLEAR**.

Playing Media on Data CDs

Upon inserting an data CD, the player will begin playing any MP3, MPEG, or JPEG files stored on the disc..

Controlling Playback

Press **■** to stop playback.

Press **▶||** to pause playback, then again to resume playback.

Press **◀◀** to return to the previous file.

Press **▶▶** to skip to the next file.

The On-Screen Display

Press **DISPLAY** to bring up the OSD. It differs depending on the type of file being played.

- For MPEG files, the OSD displays the current file number, total files, and current playback time.
- For JPEG files, the OSD displays the current file number, total files, and current file name.
- For MP3 files, the OSD displays the directory structure (see below).

Navigating the Directory Structure

The directory structure menu allows you to navigate and playback the files on the current disc. When playing MPEG or JPEG files, press **■** to bring up the directory structure. When playing MP3 files, the directory structure will display at all times.

Use the arrow controls to scroll through the files on the disc, and press **ENTER** to playback a file.

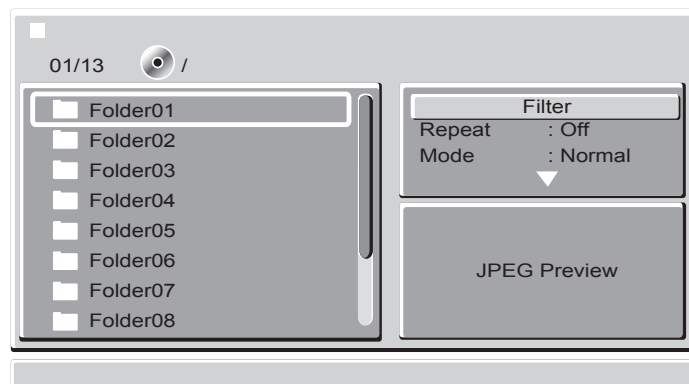

Press **▶** to access the options on the right of the screen. Use **▲** and **▼** to highlight an option, then press **ENTER** to select or change it.

Repeating Tracks

Press **REPEAT** to cycle through the repeat options: the current file, all files on the disc, and off.

Manipulating Images

When displaying JPEG images, you can change the orientation of the image by pressing the arrow keys:

- **Up**—Original orientation (0°)
- **Left**—Rotate 90°
- **Down**—Rotate 180°
- **Right**—Rotate 270°

Playing Media on Data CDs

Using Slideshow Transition Effects

To change the transition effect used for JPEG slideshows, press ANGLE repeatedly to cycle through the options:

- None
- Wipe Down
- Wipe Up
- Center In
- Center Out
- Vertical Blind
- Random

Kodak Picture CDs

Kodak Picture CDs behave the same as data CDs containing JPEG files. All the same functions and menus are available.

Configuring the Player

The Setup menu allows you to configure the operation of the player. You can change video, audio, and language settings, control access to mature programming, and configure other general display behavior.

To use the Setup menu:

1. Press the **SETUP** button to bring up the menu.
2. Once the menu appears, use the **▲** and **▼** buttons to navigate the sub-menus listed at the side of the menu.
3. Press **ENTER** to enter a sub-menu. (Press **◀** repeatedly to leave a sub-menu.)
4. Press **▲** and **▼** to select an item.
5. Press the **ENTER** button to bring up a list of the available options.
6. Press **▲** and **▼** to select the desired option and then press **ENTER** to select it.
7. Press the **SETUP** button to exit the menu.

The following is a description of the contents of the Setup menu and their use.

Language

This menu allows you to change the language used by the player for menus, audio, and subtitles.

OSD Language

Changes the language of the Setup menu and the OSD, which displays information about the current media and settings. The options are English, French, and Spanish.

Subtitle

Changes the default language used for DVD subtitles. The options are English, French, Spanish, Auto, and Off.

Audio

Changes the default language used for DVD audio. The options are English, French, and Spanish.

DVD Menu

Changes the default language used for DVD menus. The options are English, French, and Spanish.

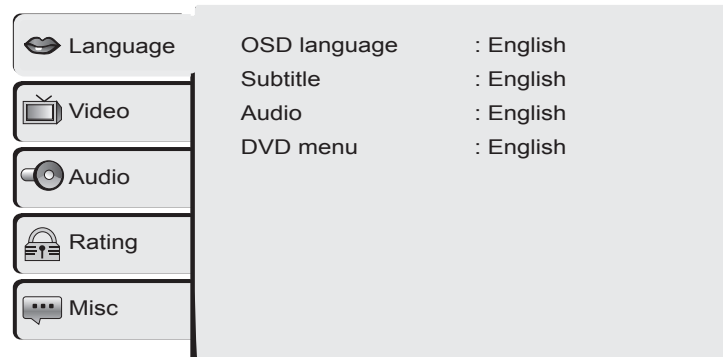

Configuring the Player

Video

The Video menu allows you to change display parameters for the external display to which the player is connected.

TV Type

Selects the format used by the display:

- **4:3**—For 4:3 format displays.
- **16:9**—For 16:9 format displays.

View Mode

Sets the video display mode for the selected display type:

- **Fill**—Fills the entire screen by stretching the video image.
- **Original**—Displays the video as it was recorded. Depending on the disc, there may be black bars along the top and bottom or the sides of the display.
- **Auto Fit**—Automatically fits the video to the screen format.
- **Pan Scan**—Uses pan and scan for 4:3 format displays, cropping the video so it fits the screen.

TV System

Selects the video format used by the disc being played:

- **NTSC**—A format used primarily in North and Central America
- **PAL**—A format used in various parts of the world, including Europe, Asia, South America, and the Middle East
- **Automatic**—Automatically detects the video format

Video Output

Sets the video output format used by the player:

- **S-Video**
- **YUV** (composite video)
- **P-Scan** (progressive scan component video)

Select the appropriate format for the output you are using.

Smart Picture

Optimizes the display for certain types of video:

- **Standard**
- **Vivid**
- **Cool**
- **Personal**

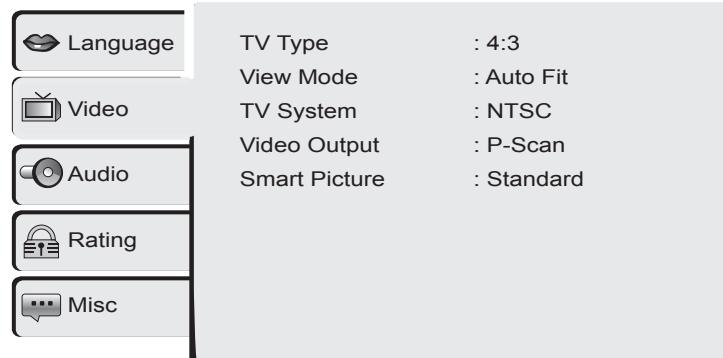

Audio

This menu configures the player for your speaker setup.

Bass Management

Turns bass management on and off for better sounding bass.

Front Speakers

When bass management is enabled, sets the size of the front speakers: Small or Large.

Center Speaker

Turns the center speaker on and off. When bass management is enabled, this also allows you to select the size of the center speaker: Small or Large.

Surround Speakers

Turns the surround speakers on and off. When bass management is enabled, this also allows you to select the size of the surround speakers: Small or Large.

Subwoofer

Turns the subwoofer on and off.

Test Tones

Allows you to play a test tone through each of the speaker channels.

Center Spkr Delay

Delays the center speaker audio by up to 1.7 meters, in increments of one-third of a meter.

Surr Spkr Delay

Delays the surround speaker audio by up to 5.1 meters, in increments of approximately 1 meter.

Digital Output

Sets the digital audio output format to RAW or PCM or turns the output off.

Language	Bass Management	: Off
Video	Front Speakers	: Large
Audio	Center Speaker	: None
Rating	Surround Speakers	: None
Misc	Subwoofer	: None
	Test Tones	: Off
	Center Spkr Delay	: No Delay
	Surr Spkr Delay	: No Delay
	Digital Output	: RAW

Configuring the Player

Rating

The Rating menu configures access to mature content, allowing you to block mature content with a password.

Parental Control

Selects the content rating above which a password will be required:

- 1. Kid Safe
- 2. G
- 3. PG
- 4. PG-13
- 5. PG-R
- 6. R
- 7. NC-17
- 8. Adult

Set Password

Sets the password for parental control. To change the password, select **Set Password**, press **ENTER**, enter the current password, and then press **ENTER** again. Then select **Set Password** again, press **ENTER**, enter the new password, and then press **ENTER** again.

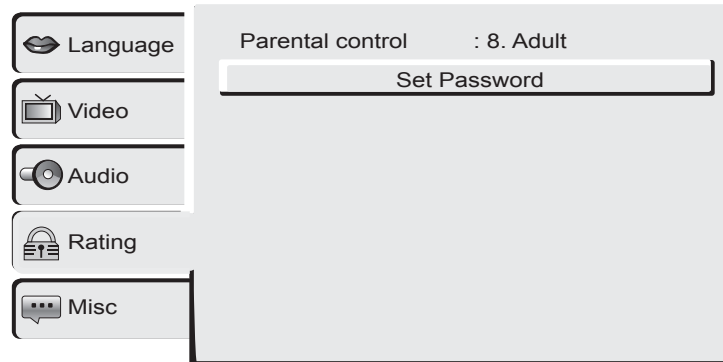

Misc

The Misc menu contains general player settings that do not belong in the other categories.

Use Default Settings

Resets the player to factory settings. Select and press **ENTER**, then select **Yes** to reset or **No** to abort.

Screen Saver

Turns the screen saver on and off. When enabled, the screen saver will blank the screen after a period of inactivity.

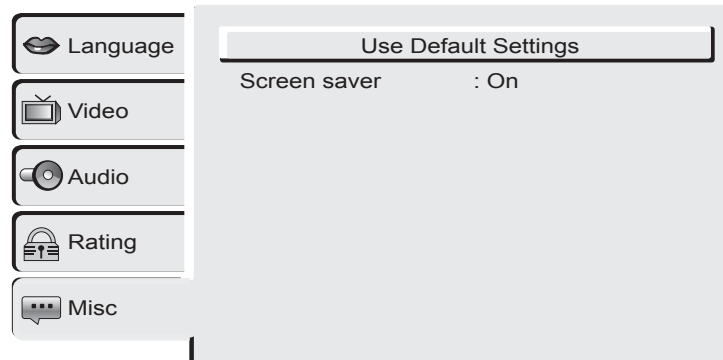

Troubleshooting

Symptom	Possible Cause	Resolution
Power does not come on	Power cord not securely connected	Make sure the power cable is firmly inserted into the wall outlet.
	Power outlet is off or not working	Try plugging a different device into the outlet and see if it turns on. If not, check that the outlet is on or use a different outlet.
	Player main power is off	Ensure the power button on the player itself is on.
No picture	Player is off	Press the power button on the player to turn the player on. Then, if needed, press the power button on the remote.
	No signal	Make sure the proper source is selected on the external display. If there is still no picture, check the signal cable(s) and ensure the player is on and working.
Display is too dark or too bright	Contrast or brightness too low or too high	Adjust the contrast and/or brightness to desired setting on the display.
Distorted image	Display format set incorrectly	Check that the correct display format is selected in the Setup menu (see "Video" on page 24).
Unclear or noisy picture	Signal cable(s) not securely connected	Make sure the signal cable(s) are firmly connected.
	Radio interference	Check for any electronic devices nearby that might be interfering with the video signal or the player's operation.
No sound	Audio cable(s) not securely connected	Make sure the audio signal cable(s) are firmly connected.
	Audio muted	Unmute the audio by pressing the MUTE button on the remote.
	Subwoofer is off	Turn on the ON/OFF switch.
	Speaker system format set incorrectly	Make sure the 2.1CH/5.1CH switch on the back of the subwoofer is set correctly.
	Audio settings set incorrectly	Check the audio settings in the Setup menu (see "Audio" on page 25).

Troubleshooting

Symptom	Possible Cause	Resolution
Distorted sound	Audio settings set incorrectly	Check the audio settings in the Setup menu (see "Audio" on page 25).
	Speaker system format set incorrectly	Make sure the 2.1CH/5.1CH switch on the back of the subwoofer is set correctly.
	Audio cable(s) not securely connected	Make sure the audio signal cable(s) are firmly connected.
Remote control not functioning	Battery inserted improperly	Make sure the batteries are inserted and oriented properly.
	Battery low on energy	Replace the batteries.
	A button is stuck	Jog any stuck buttons on the remote to unstick them.
	Obstacle between remote and player	Remove the obstacle.
	The remote is too far from the player	Move closer to the player.
"Bad disc" displays upon disc insertion	Unreadable disc	Ensure disc is not scratched or dirty. Clean and re-insert as necessary.
	Disc format not supported	Ensure the disc has a format compatible with the player (see "Specifications" on page 29).

Note: Further troubleshooting information may be found on the Spectroniq website at www.protronusa.com.

Support Information



Do not return this product to your retailer until you have performed the steps laid out in "Unpacking Your New Home Theater System" on page 2 and contacted the customer service center. Merchandise may not be returned to Spectroniq without a return form authorization.

Before contacting Spectroniq customer service, please record the following information, which may be found on the rear of your DVD player:

- Model Number
- Serial Number

The Spectroniq customer service center may be contacted 24 hours a day, 7 days a week at the following number:

1-888-257-8899

Specifications

General

Player Dimensions—in. (mm)	16.9 (430) W × 1.5 (38) H × 9.8 (250) D
Subwoofer Dimensions—in. (mm)	5.87 (149) W × 11.4 (290) H × 9.84 (250) D
Speaker Dimensions—in. (mm)	3.5 (90) W × 4.92 (125) H × 3.3 (85) D
Weight	19lbs
Playback Formats	DVD, DVD+R/RW, Audio CD, VCD, SVCD, Kodak Picture CD, CD-ROM, CD-R/RW, MP3, JPEG

Outputs

1 × composite video (RCA)
1 × S-Video
1 × progressive scan component video (RCA)
1 × digital coaxial audio (RCA)
1 × digital optical audio (TOSLINK)
1 × stereo audio (RCA)
1 × 5.1 channel audio (RCA)

Power Input

AC110–230V, 50–60Hz

Power Consumption

12W

Storage Temperature

0–60°C

Operating Temperature

5–45°C

Operating Humidity

10–90%

Speaker System

Subwoofer Output Power	30W
Subwoofer Frequency Response	85Hz–2kHz
Satellite Output Power	5W
Satellite Frequency Response	200Hz–20kHz

Video

Sample Rate	54MHz
Resolution	10 bits
Display Resolution	500 lines
S/N Ratio	>56dB
Harmonic Distortion	<0.5%

Audio

Max. Sample Rate	96kHz
Resolution	24 bits
Frequency Response	±3dB, 20Hz–20kHz
S/N Ratio	>90dB
Dynamic Range	>90dB
Channel Separation	>75dB
Harmonic Distortion	<0.1%



Limited Warranty

Spectroniq warrants this product to be free from manufacturing defects in material and workmanship under normal use for the period listed at the bottom of this document.

How to obtain service:

- Contact Customer Support at 1-888-257-8899. If the issue cannot be resolved over the phone with troubleshooting techniques, you may be eligible for warranty service. All warranties must be authorized by Spectroniq prior to service and will result in the issuance of an authorization number for service.
- Proof of purchase in the form of a bill of sale or receipted invoice with product name, model and serial number, which provides evidence that the product is within the warranty period, must accompany the product to obtain warranty service.

This warranty does not cover:

- Physical or cosmetic damages.
- Damage caused by abuse and/or neglect.
- Ordinary adjustments as outlined in the owners manual that can be performed by the customer.
- Damage to equipment not properly connected to the product.
- Any cost incurred in shipping the product for repair.
- Signal reception problems caused by external antenna, cable systems or interference.
- Incompatibility due to a change in TV/CATV broadcast systems after the product was sold.
- Batteries.
- Images burnt onto the screen.
- Initial installation and related adjustments.
- Power surge and/or damage by lightning.
- Force majeure or uncontrollable external force damage.
- Product shipped for service with inadequate packaging or packaging materials.

What we will do:

- Spectroniq will assess the product and cover all labor charges to repair your product.
- Spectroniq will provide new or, at our discretion, refurbished replacement parts required to repair your product.

This warranty is void if:

- Product is used in a commercial application or rental.
- Damaged through misuse, negligence or abuse.
- Modified or repaired by anyone other than authorized Spectroniq service center.
- Damaged because it is improperly connected to any other equipment.
- If the original proof of purchase cannot be supplied.
- If the identifiable markings on the product, such as serial number, are defaced, unrecognizable, or missing.
- The product is used outside the country in which it was originally sold.



This warranty is non-transferable and only applies to the original purchase. Any implied warranties, including the warranty of merchantability, are limited in duration to the period of this expressed warranty and no warranty whether expressed or implied shall apply to the product thereafter. Under no circumstance shall Spectroniq be liable for any loss or consequential damage arising out of the use of this product. This warranty gives specific legal right. However, you may have other rights that may vary from state/province to state/province. Some states/provinces do not allow limitations on implied warranties or exclusions of consequential damage. Therefore these restrictions may not apply to you.

90 days Labor and Parts

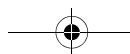
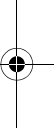

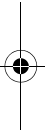

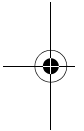

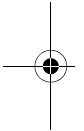

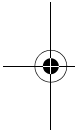

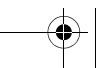
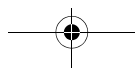
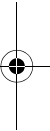
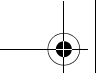

<http://www.protronusa.com/>

PHT-300X

OMPHT300X-1